

Dr's Light

User manual

Eng

CE

| | |
|-------------------------------|-----------|
| 1. Introduction | 04 |
| - Features | |
| - Description | |
| 2. Safety Information | 05 |
| - Warning and caution | |
| - Notes and reference | |
| - Installation and Connection | |
| - Operation | |
| - Maintenance | |
| 3. List of Components | 09 |
| 4. Parts and Functions | 10 |
| 5. Installation | 11 |
| 6. How to use | 14 |
| 7. Maintenance | 17 |
| 8. Trouble Shooting | 18 |
| 9. Specification | 19 |
| 10. Accessories | 20 |
| 11. Warranty | 20 |
| 12. Warranty card | 21 |

1 Introduction

Thank you for purchasing the device. The instructions described below have been designed to provide the necessary information for the successful operation, daily maintenance and safety for the use of this device.

Features

- High intensity
- Various curing program modes and time setting
- Interchangeable battery
- Color OLED screen
- Unique thermal control system
- Ergonomic design

Description

Polymerization of light-cure catalyst containing dental materials.

2 Safety information

It is important to understand the following information to use this product safely.

Warning and caution

Warning and caution used in this manual are shown below.



Indicates a potentially hazardous situation which, if not avoided, may result in serious injury or death.



Indicates a potentially hazardous situation which, if not avoided, may result in minor/moderate injury or in damage of property.

Notes and references

Notes and references used in this manual are shown below.



Indicates that potential malfunctions may occur if the description is ignored.



Supplementary information to facilitate better operation.

2 Safety information

Installation and Connection



Warning

- The adaptor should be disconnected from charger before connect the power cable to prevent an electric shock.
- Keep away from sources of ignition to avoid fire or explosion.
- Protect the handpiece, charger, and battery from any liquid to avoid electric shock or functional error.
- Place the charger on a flat and stable surface. Do not drop handpiece and charger to avoid internal defect that may cause overheating or fire.
- Do not place the electrical cord near a gas burner or sources of heat. If the cord catch on fire, replace to new one to avoid short-circuit.



Caution

- Do not use or leave the unit in areas of high temperature or exposed to direct sunlight. Internal circuit may cause overheat or fire.
- Securely connect the power plug to the outlet with dust-free.
- Do not touch the terminal areas of charger or battery with fingers or conductive objects such as metal wire or safety-pin. It may electric shock or fire.
- Do not use other charger. It may cause fire or device malfunction.

2 Safety information

Operation



Warning

- Do not plug the power cord with wet hands. This may result in an electric shock.
- In case of fluid leak from battery or partial discoloration / deformation of the handpiece, immediately stop use.
- Place the battery on correct direction when charging. Wrong directed placing may cause malfunction, explosion, or fire.
- In case partial discoloration of the charger, immediately disconnect the power plug and repair the charger.
- In case battery fluid contacts the eye, immediately flush with copious amount of clean water and get medical attention.
- Do not use this device on patients with a history of cataract, retinal damage or allergic reaction to light.
- Do not use this device on a person with a pacemaker as it may cause malfunction of pacemaker.
- Avoid exposing the light on intraoral soft tissue as it may affect the soft tissue.
- Use carefully the guide tip to avoid broken.
- Do not put the battery on the charger upside down. This may cause an explosion or fire.



Caution

- Disconnect the power cord by grasping the power plug. This may cause injuries or burns.
- Avoid damage or use of unnecessary force on the power cord. This may cause an electric shock or fire.
- Should battery fluid contact the skin or clothes, immediately wash it off with copious amount water to avoid skin damage.
- Take the battery out of from handpiece, if it won't be used for long time.
- Connect the power plug only when battery is being charged. Insulation degradation may cause electric shock or fire.
- Do not use this product for any purposes other than dental use.
- The product may malfunction or turn off due to static electricity.

2 Safety information

Maintenance



Warning

- Use only the battery supplied to avoid fluid leak or explosion.
- Never disassemble or overhaul the product. Unusual performance may cause injuries, electric shock, or fire.
- Ensure that charger and battery are always separated from the handpiece prior to cleaning.



Caution

- If the OLED screen malfunctions, remove the battery from the handpiece and reinsert it.
- User must be in charge of operation, maintenance and check.

3 List of components

Please check the contents described below when removing the contents from the original packaging.

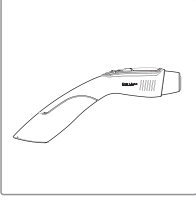

Handpiece

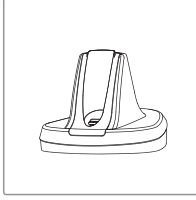

Charger

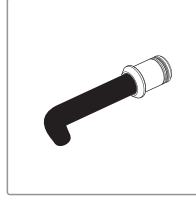

Guide tip 8mm

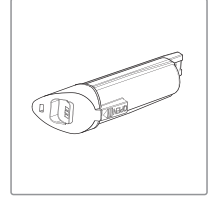

Battery

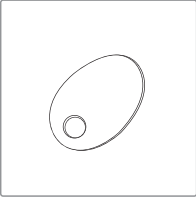

Anti-glare Shield

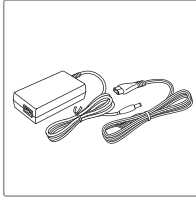

Adpater & Power cable

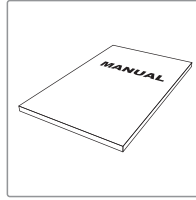

Manual

4 Parts and functions

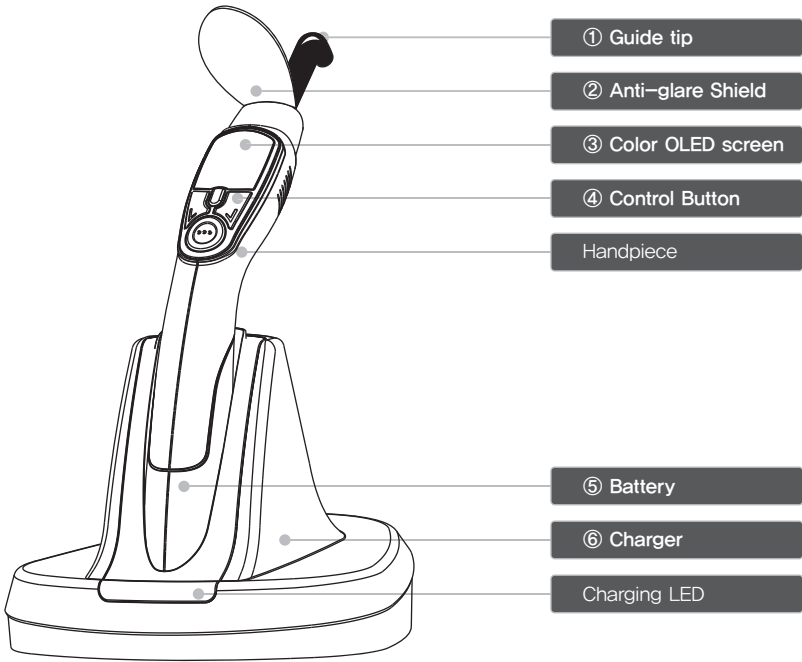

① Guide tip

- Effectively exposes the LED light

② Anti-glare shield

- It is placed on the guide tip to protect eyes from exposure to light.

③ Color OLED screen

- Selected mode, exposure time and remaining battery are displayed on the OLED screen in graph mode or text mode.

④ Control button

- T/W button: Short click to turbo mode
- Time button
- Mode button
- Operation button

⑤ Battery

⑥ Charger

5 Installation

1. Connection between AC adapter and charger

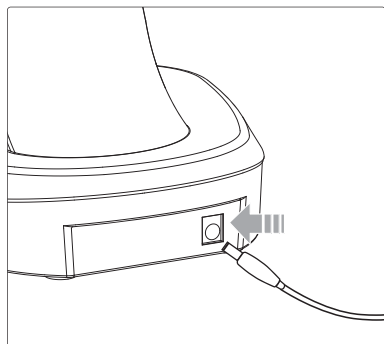

- Securely insert the connector of the AC adapter into the inlet at the back of the charger.

- The AC adapter is able to use with a power outlet of 100V~240V

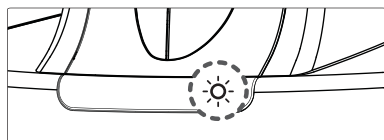

- When the power plug is connected both red and green lights flash instantly which is not a malfunction or an alarm sign.



Note

Use only the original AC adaptor supplied.

2. Inserting battery

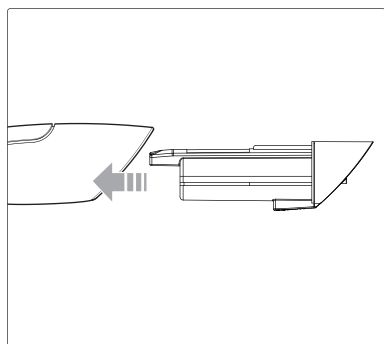

- Carefully insert the battery into the handpiece as directed by the arrow. Avoid forcing the battery pack.

5 Installation

3. Inserting guide tip

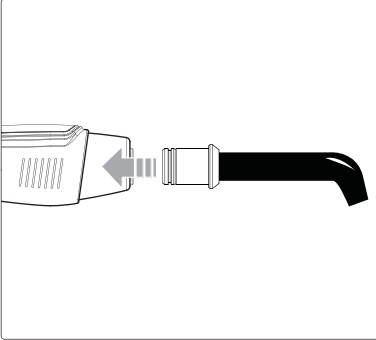

- Slowly insert the guide tip into the handpiece.
Push the guide tip in till it firmly sets into position

4. Placing anti-glare shield

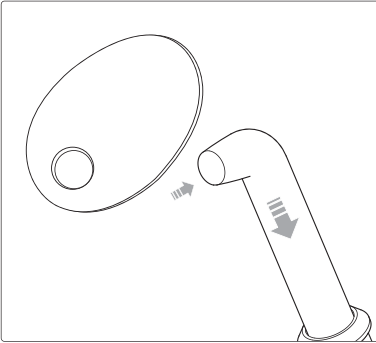

- Place the anti-glare shield on the guide tip.

5 Installation

5. Charging

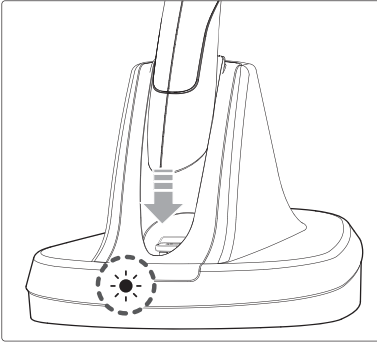

- Insert the handpiece into the vertical slot at the front of the charger. The charger light at the front of the charger will appear.

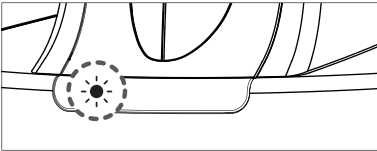

- Red light on: Charging in progress.

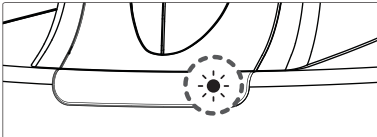

- Green light on: Charging process is complete.



Note

- If the remaining battery is extremely low, red light may flickers while recharging, which is not a malfunction.
- It will take approximately 3 ~ 4 hours before the battery will be fully charged.
- Depending on the volume of the remaining battery, the sign of battery indicator varies.

6 How to use

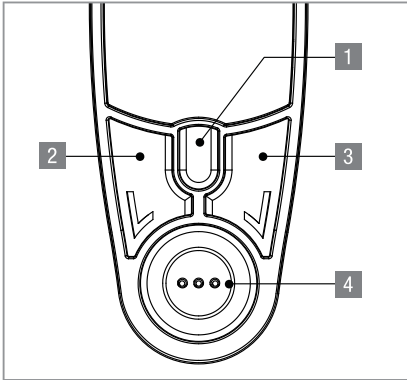

- 1) T/W mode button
- Click: Turbo mode
- 2) Time button
- Time select
- 3) Mode button
- Mode select
* Normal-> High-> SoftStart-> Pulse
- 4) Operation button
- Light irradiation
- Power on/off

1. Activating handpiece

- Press the operation button gently. The OLED screen will be on standby mode and display the mode used last with a short audible tone.



Intro display



Last used mode

2. Selection of the display mode

- Select the display mode (Graphic or Text) by pressing mode button for 1.5 sec. Beeps will indicate that the selection is complete.

<Graph Mode>



Graph Mode Display

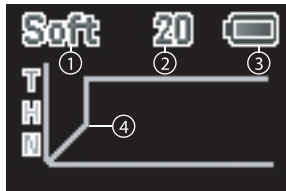

- ① Program mode
- ② Time
- ③ Battery
- ④ Output graph

6 How to use

<Text Mode>



Text Mode Display

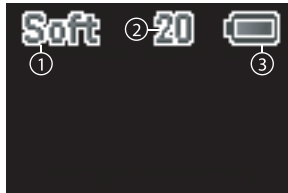

- ① Program mode
- ② Time
- ③ Battery



- ① Remained time



Note

Initially, the selected curing time is displayed and subsequently the remaining time is displayed during the curing process.

3. Start of exposure

- Press operation button to start exposure with the selected mode.



Reference

Press any button if you wish to end the curing process.

4. Battery icon



- This icon indicates the power remaining in the battery.



- Recharge or replace the battery when "LOW BATTERY" sign appears on the display screen.

5. Sleep mode

- The unit OLED screen is off after 30 seconds in case without using. Grip the unit and it will be turn on.
- The unit turns off after 1 hour in case without using.



Reference

To turn on press operation button.

6 How to use

6. Set-up memory

- This handpiece will record the setting used last.

7. Selection of curing mode

- Six curing programs are available in this device.

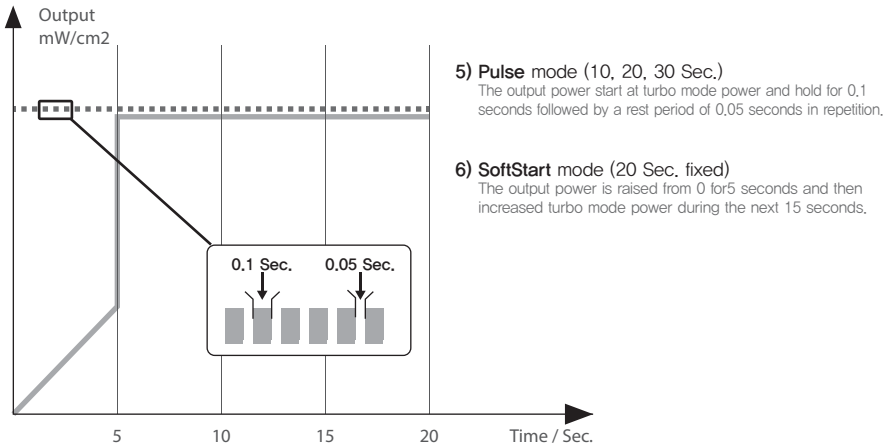
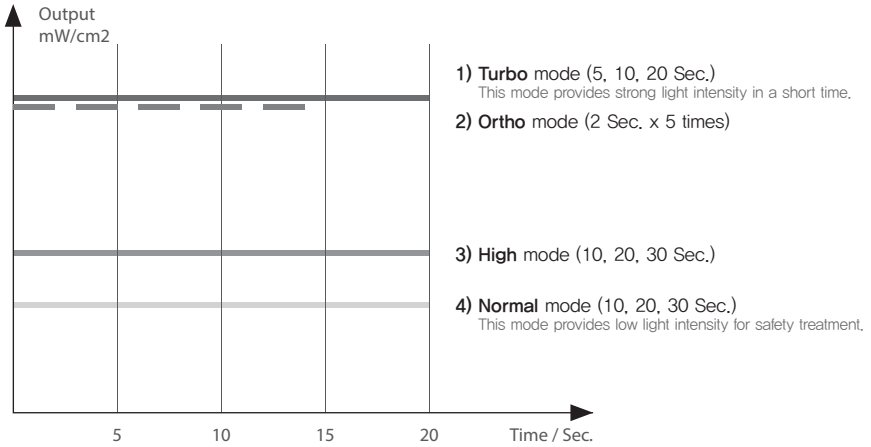

7 Maintenance

Cleaning and sterilization

- Avoid wetting the handpiece and charger to prevent electrical shock. Ensure that the charger and battery are always separated from the handpiece prior to cleaning.
- Clean the handpiece and charger gently with a clean, soft, lint-free cloth. Avoid using solvents containing oil or ethanol or acetone, sharp or pointed tools to clean as they may damage or scratch the plastic.
- Clean the guide tip with a soft cloth and disinfect. The guide tip is autoclaveable.
- Remove restorative materials stuck to the guide tip gently with a plastic spatula. Avoid using sharp tools as they may scratch the surface of the guide tip and affect the intensity of the light.

Maintenance and replacement of the battery

- Exposure to high room temperature may shorten the battery life. The recommended room temperature ranges between 15 to 25°C normal temperature. Extremes of room temperature will affect the operation of the LED light.
- It is recommended for the rechargeable battery to be charged immediately before use to maximize the efficiency.
- Remove the battery from the handpiece, if not being used for long time.
- If the running time declines with a full-charged battery, replace the battery before use.

Sterilization Method

| | |
|-----------------|-----------------|
| Sterilizer type | Steam (Gravity) |
| Configuration | Wrapped |
| Temperature | 121 °C |
| Exposure Time | 20 minutes |
| Dry Time | 10 minutes |

8 Trouble shooting

If the device does not work normally, please refer to the following points.

| Problem | Cause and solution |
|------------------------------------|----------------------------------------------------------------------------------------------------------------------------------------------------------------------------------------------------------------------------------------|
| Buttons are not operating normally | <p>If the button is pressed with excess force, the power will automatically be switched off. In such a case press the button gently.</p> <p>In case it still does not operate normally, reconnect the battery to reset the device.</p> |
| Display screen does not light | <p>If the battery is completely discharged or connected incorrectly, display will not appear.</p> <p>Recharge the battery or reconnect the battery to reset the device.</p> |
| Power off while in operation | <p>If the operation button is pressed for more then 2 seconds, power will be switched off. Press the operation button again to restart the device.</p> <p>Check the battery connection.</p> |
| Not able to charge | <p>If the power cord is not correctly connected to the charger, or the handpiece is not properly placed on the charger.</p> <p>Clean the charger or the charging terminal.</p> |
| When intensity of light is poor | <p>If the guide tip has dirty or is damaged and the battery is not charged enough, intensity of light becomes poor. Replace with new guide tip or new battery.</p> |

* If the trouble is not fixed after following solution, please contact your local dealer or manufacturer.

9 Specification

■ Equipment Class

| | |
|-------------------------------------|-------------------------------------------------------------------------------------------|
| Model: | Dr's Light |
| Safety: | IEC60601-1 |
| EMC (Electro-Magnetic Compliance): | IEC60601-2 |
| Protection from electric shock: | Type BF  |
| Protection from ingress of liquids: | IPX0 (ordinary equipment) |
| Operation: | Intended for continuous operation |

■ Operation, transport, and storage condition for the main unit

| | Operation | Storage | Transport |
|----------------------|----------------|---------|-----------|
| Temperature | 10~40C | 0~40C | -10C~50C |
| Humidity | 10~80% | 0~80% | 0~80% |
| Atmospheric pressure | 800 ~ 1060 hPa | | |

■ Additional Information

| | | |
|-----------|-----------------|---------------------------------------|
| Handpiece | Dimensions | Approx. 215 x 96 x 37 mm |
| | Weight | Approx. 175 g (including the battery) |
| Charger | Dimensions | Approx. 175 x 178 x 137 mm |
| | Weight | Approx. 225 g |
| Battery | Type | Lithium-ion battery |
| | Nominal voltage | DC 3.7V |
| | Dimensions | Approx. 107 x Max. H33mm |
| | Weight | Approx. 65 g |

* this specification is subject to change without prior notice.

10 Accessories

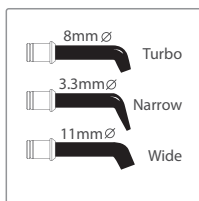

Guide tip

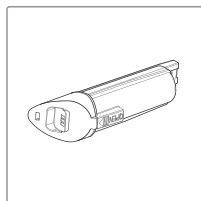

Battery

11 Warranty

This device is only shipped after strict inspection. Should the product incur any problems under normal use conditions within one year from the date of purchase, the repair will be free of charge. However, repair of consumables (Guide tip, Battery, and etc.) are not covered by the warranty. For more information, refer to the 12. Quality Assurance.

Serial number check.



 **Good Doctors Germany GmbH**

Gerhard-Domagk-Str. 2, 53121 Bonn, Germany
TEL: +49 (0) 228/53 44 14 65 FAX: +49 (0) 228/53 44 14 66
www.gooddrs.de

 **Good Doctors Co., Ltd.**

#208, B-dong, 283 Bupyeong-daero, Bupyeong-gu
(Woolim Lions Valley, Cheongchoen-dong), Incheon, 21315,
Republic of Korea
Tel : + 82 32 424 6325 Fax : + 82 32 424 6326
E-mail : info@gooddrs.com Website : www.gooddrs.com

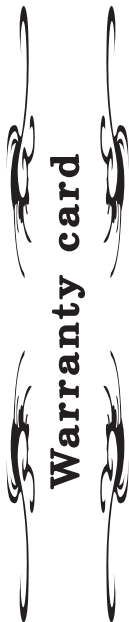

We guarantee the quality of the product as follows

Name of product :

< Assurance details >

Name of model :

1. If there is any defect of manufacturer or product has any fault itself within the assurance period, it will be replaced with the same product.

Customer information

- Office name :
- Office phone :

2. Below cases are not effective for the free refund.

- Malfunction and damage according to user's carelessness.
- Malfunction and damage according to natural disaster such as fire, earthquake and flood etc.
- Malfunction and damage according to user's intention or accident.
- Malfunction and damage according to using incompatible product.

Assurance period

- Date of purchase : from , 20
- Product is for 1 year except accessories.

3. The manufacturer does not accept any liability resulting misuse.



Good Doctors Co., Ltd.

#208, B-dong, 283 Bupyeong-daero, Bupyeong-gu (Woolim Lions Valley, Cheongchoen-dong), Incheon, 21315, Republic of Korea
 Tel: +82 32 424 6325 Fax: +82 32 424 6326



Rev.13 - Jan. 2020

Good Doctors Co., Ltd.

Address. #208, B-dong, 283 Bupyeong-daero, Bupyeong-gu (Woolim Lions Valley, Cheongchoen-dong), Incheon, 21315, Republic of Korea
Tel. +82-32-424-6325 Fax. +82-32-424-6326 Website. www.gooddrs.com E-mail. info@gooddrs.com